

- 200.12800 - KWIKTRAK 90MM, 2M
- 200.12810 - KWIKTRAK 90MM, 3M
- 200.12815 - KWIKTRAK 90MM, 4M
- 200.12820 - KWIKTRAK 90MM, 6M

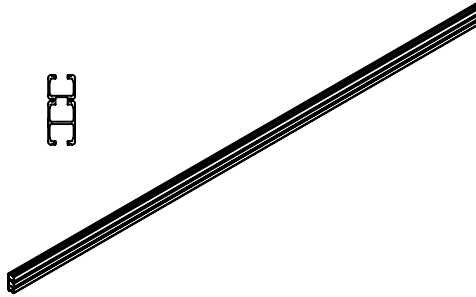

- 200.12870 - KWIKTRAK 140MM, 4.5M
- 200.12872 - KWIKTRAK 140MM, 3.5M
- 200.12874 - KWIKTRAK 140MM, 3.0M
- 200.12876 - KWIKTRAK 140MM, 2.5M

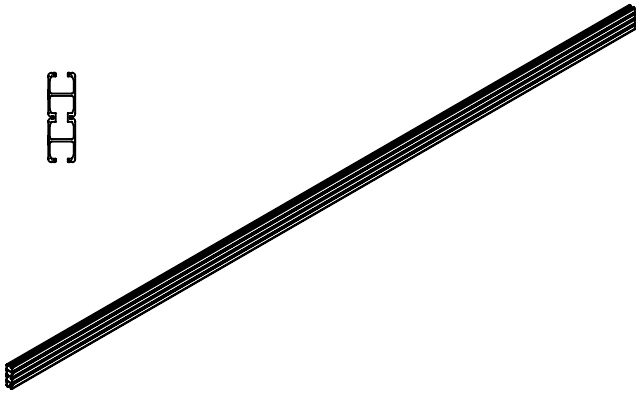
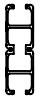

- 200.12880 - KWIKTRAK 180MM, 6.0M
- 200.12881 - KWIKTRAK 180MM, 2.5M
- 200.12882 - KWIKTRAK 180MM, 3.5M
- 200.12883 - KWIKTRAK 180MM, 4.0M
- 200.12884 - KWIKTRAK 180MM, 4.5M
- 200.12885 - KWIKTRAK 180MM, 5.0M
- 200.12886 - KWIKTRAK 180MM, 5.5M

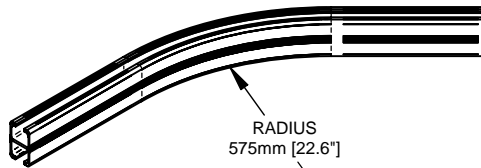

700.12840  
45 DEGREE KWIKTRAK CURVE

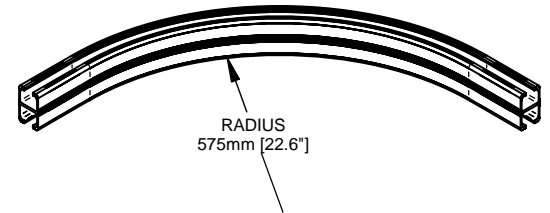

700.12860  
90 DEGREE KWIKTRAK CURVE

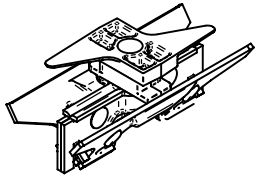

700.11100  
TRACK BRACKET  
10 / BOX

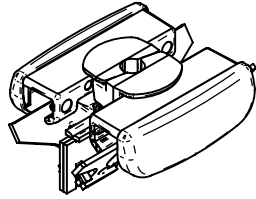

700.11105  
KWIKTRAK BRACKET FOR JOINT  
10 / BOX

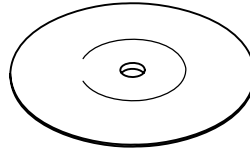

200.11140  
100MM CEILING PLATE  
100 / BOX



200.11150  
1.5MM BRACKET SHIM  
200 / BOX



200.11160  
3MM BRACKET SHIM  
200 / BOX

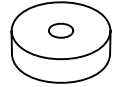

200.11170  
12MM BRACKET SHIM  
100 / BOX



000.00810  
SPRING PIN  $\varnothing$ 3.2 X 38MM LONG FOR JOINT  
100 / BOX

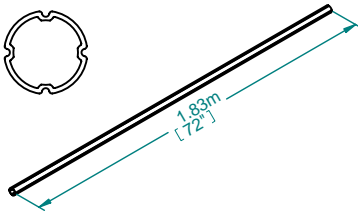

200.12970  
THREADED ROD COVER

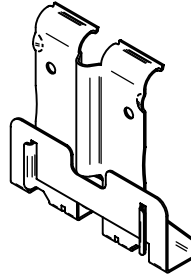

700.15570  
KWIKTRAK X-Y RETAINING ASSEMBLY

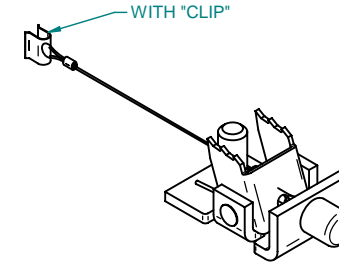

700.11005  
AUTOLOCK RAIL STOPPER

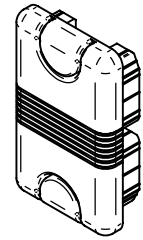

200.11060  
FLAT WHITE CAP FOR H RAIL

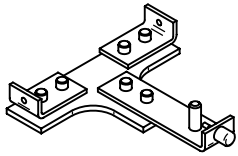

700.11220  
TRACK JUNCTION

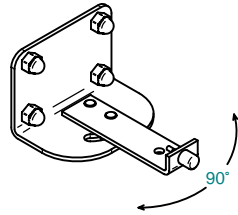

700.11020  
WALL BRACKET

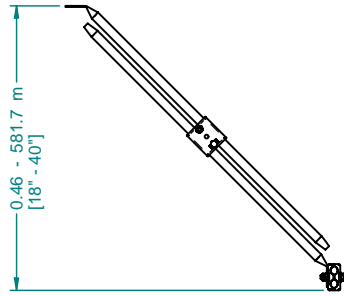

0.46 - 581.7 m  
[18" - 40"]

700.11350  
ADJUSTABLE LATERAL BRACE

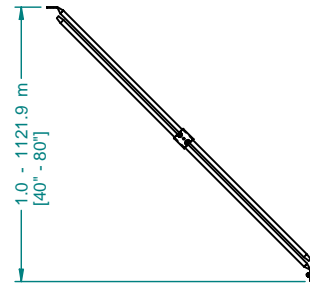

1.0 - 1121.9 m  
[40" - 80"]

700.11360  
ADJUSTABLE LATERAL BRACE (LONG)

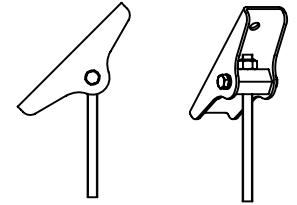

700.11370  
CATHEDRAL CEILING BRACKET

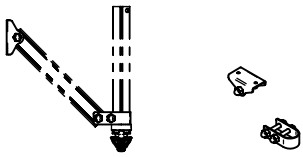

700.11380  
VISIBLE LATERAL BRACE

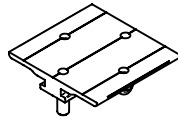

700.11205  
455kg [1000lb] TRACK BRACKET

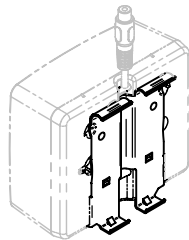

225.15540  
CLIP-ON BRACKET FOR  
CHARGER BOX

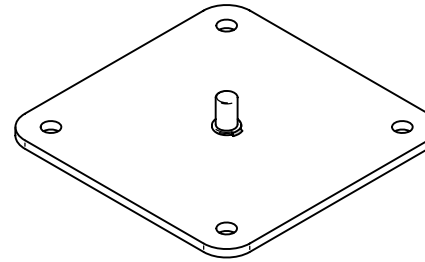

225.11380  
4-POINT FIXATION PLATE

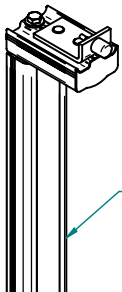

700.12900  
END OF TRACK WALL POST (1)

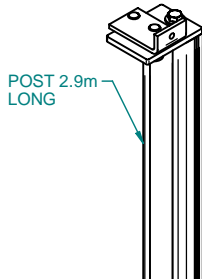

POST 2.9m  
LONG

700.12910  
WALL POST SIDE MOUNTED (1)

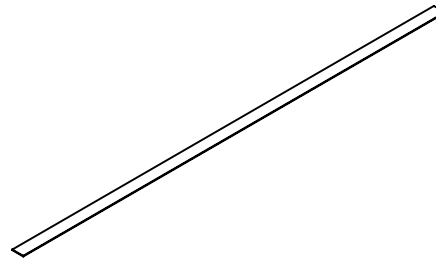

200.12980 - WALL POST SHIM 3.2mm (1/8")  
200.12985 - WALL POST SHIM 6.4mm (1/4")

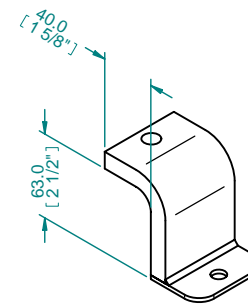

225.12910  
SPACER FOR WALL POST  
(ORDER ANCHOR 000.03660  
TO FIX SPACER ON POST)

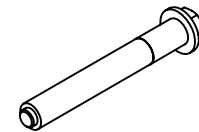

000.03660  
ANCHOR HSL M8/20  
(TO FIX SPACER ON WALL POST)

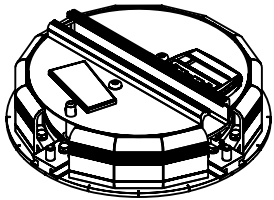

700.11600  
TURNTABLE

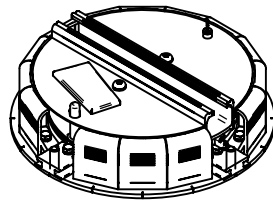

ELECTRIC TURNTABLE (FOR PORTABLE)  
700.11651 (UL) 700.11652 (JP) 700.11653 (CE)  
700.11654 (AU) 700.11655 (UK)

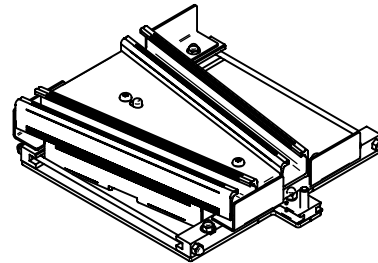

700.11700  
EXCHANGER

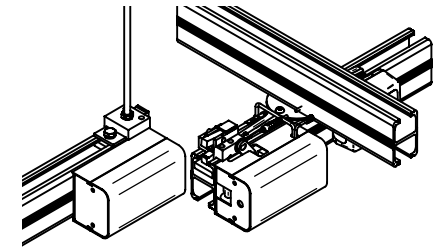

700.11500 - GATE  
700.11505 - 2 GATE COMBINAISON KIT

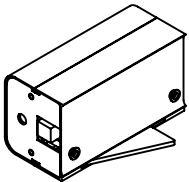

700.11550  
BOITIER FIXE GATE KWIKTRAK  
KWIKTRAK GATE FIXED BOX

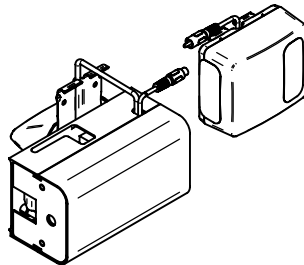

700.11560  
BOITIER MOTEUR GATE KWIKTRAK  
KWIKTRAK GATE MOTOR BOX

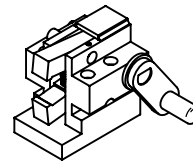

700.11570  
BLOC PINCE GATE KWIKTRAK  
KWIKTRAK GATE CLAMP

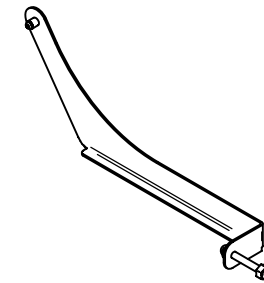

700.11635  
KWIKTRAK GATE REINFORCEMENT KIT

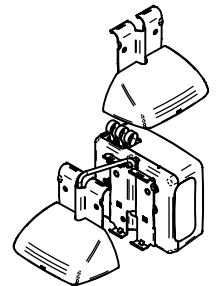

700.15515  
3 CONTACTS INTERFACE KIT

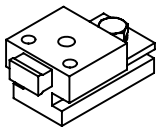

700.11580  
BLOC FIXE GATE KWIKTRAK  
KWIKTRAK GATE FIXED BLOCK

## 005.11150 - STARTING KIT (TOOLS AND SHIMS)

(1 x 005.11100 + 1 x 005.11120 + 4 x 005.11110 + 100 x 200.11140  
+ 200 x 200.11150 + 200 x 200.11160 + 100 x 200.11170)

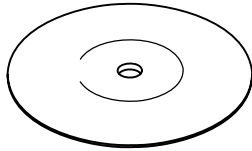

200.11140  
100MM CEILING PLATE  
100 / BOX



200.11150  
1.5MM BRACKET SHIM  
QTY = 200



200.11160  
3MM BRACKET SHIM  
QTY = 200

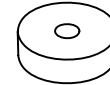

200.11170  
12MM BRACKET SHIM  
QTY = 100

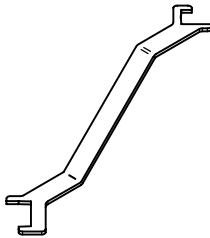

005.11100  
LOCK-UNLOCK TOOL  
QTY = 1

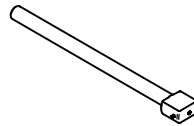

005.11120  
SPRING PIN TOOL  
QTY = 1

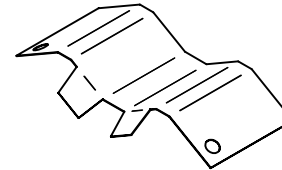

005.11110  
BRACKET REMOVING TOOL  
QTY = 4

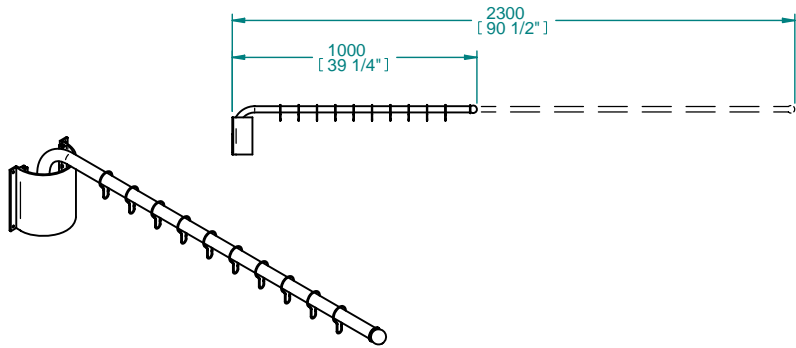

A9800  
TELESCOPIC SWIVEL POLE  
FOR SHOWER CURTAIN

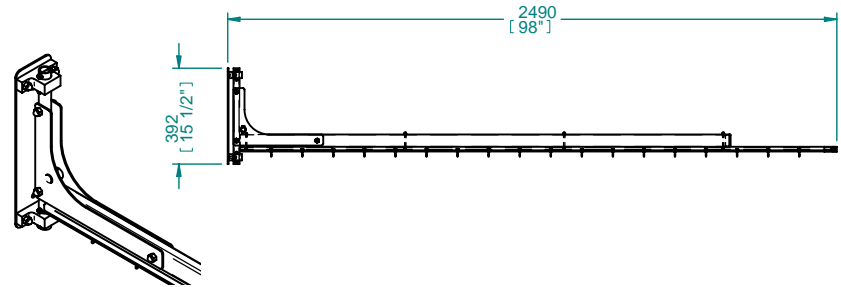

700.12000  
SWIVEL POLE FOR CURTAIN

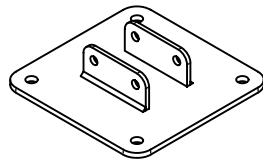

700.12032  
CEILING BRACKET FOR CURTAIN POLE

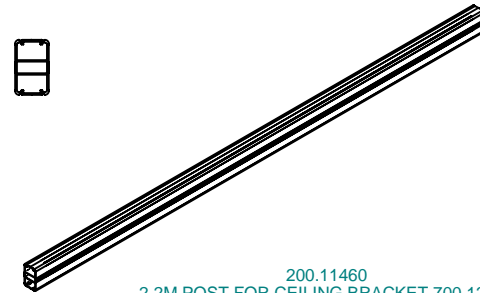

200.11460  
2.2M POST FOR CEILING BRACKET 700.12032

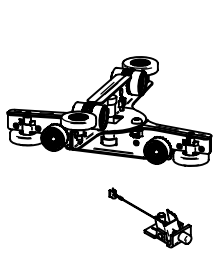

700.11290  
X-Y TROLLEY KIT  
272KG [600LB] CAPACITY

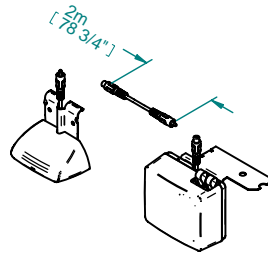
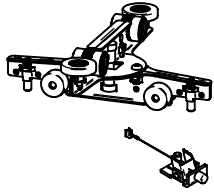

700.15510  
X-Y CHARGER INTERFACE  
(TO USE WITH 700.11290)

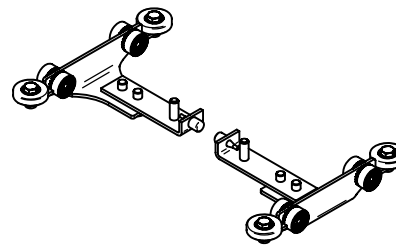

700.11295  
X-Y TROLLEY KIT FLUSH MOUNT  
(FOR PORTABLE TRACK LIFT ONLY)

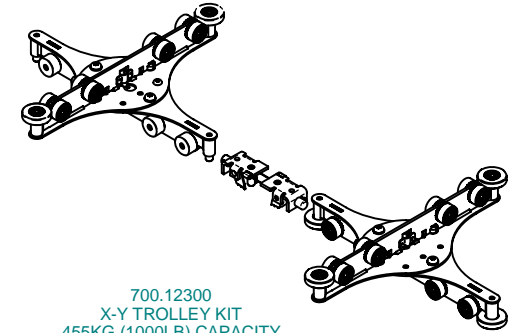

700.12300  
X-Y TROLLEY KIT  
455KG (1000LB) CAPACITY

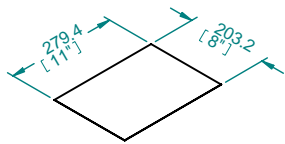

001.14045  
WHITE STICKER SHEET  
(COLOR OF RAIL)

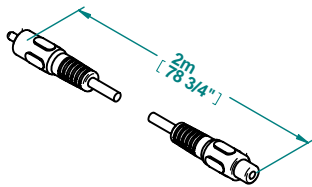

402.15505  
CHARGER CABLE EXTENSION

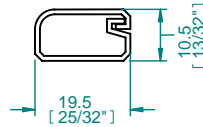

E0265  
SURFACE RACEWAY 1.8M [6']  
(SELF ADHESIVE)

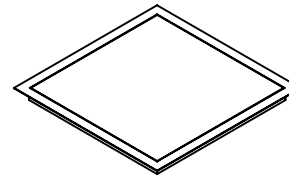

000.01260  
ACCESS DOOR 46cm x 46cm  
[18\"/>

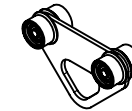

KWIKTRAK 700.10650  
TROLLEY PORTABLE  
TRACK LIFT

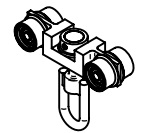

KWIKTRAK 700.10620  
SWIVEL TROLLEY FOR VOYAGER  
PORTABLE TRACK LIFT

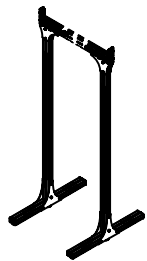

700.11900  
SEMI-PERMANENT RACK FOR KWIKTRAK  
(TRACK NOT INCLUDED)  
MAX. 455KG (1000LB)

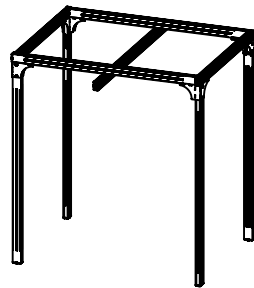

990XXXX  
X-Y SEMI-PERMANENT RACK KWIKTRAK  
REFER TO DATASHEET FOR  
"HOW TO ORDER"  
MAX 272KG (600LB)

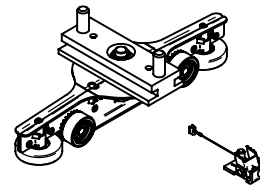

700.11285  
SHORT X-Y TROLLEY  
272KG [600LB] CAPACITY

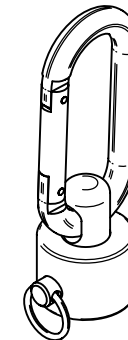

700.10950  
PIVOTING ADAPTOR  
FOR PORTABLE