

KWIKTRAK

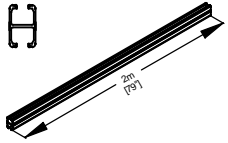

200.12800  
2 METERS, 90MM H TRACK

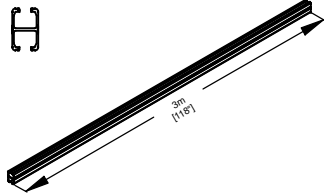

200.12810  
3 METERS, 90MM H TRACK

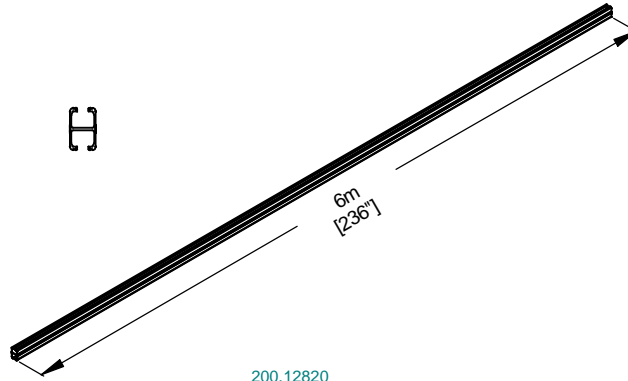

200.12820  
6 METERS, 90MM H TRACK

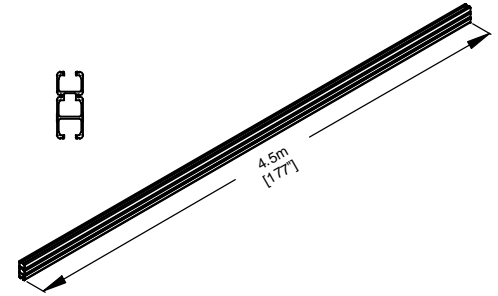

200.12870  
4.5 METERS, 140MM H TRACK

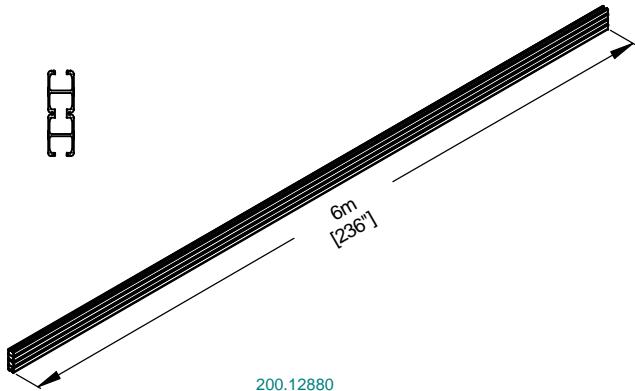

200.12880  
6 METERS, 180MM H TRACK

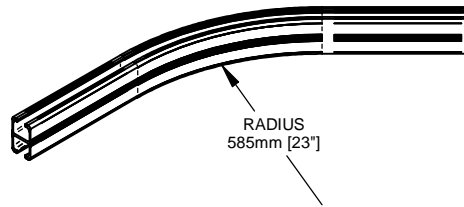

700.12840  
45 DEGRES CURVE, H TRACK

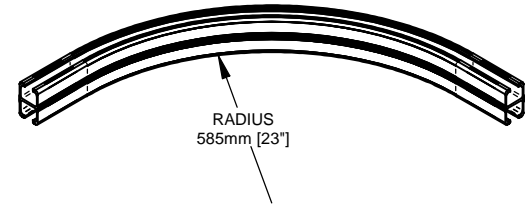

700.12860  
90 DEGRES CURVE, H TRACK

**KWIKTRAK**

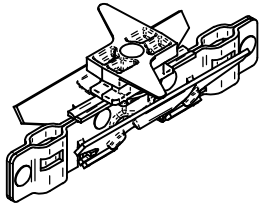

700.11100  
TRACK BRACKET  
10 / BOX

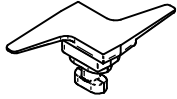

200.11105  
CAM FOR JOINT  
20 / BOX

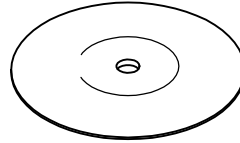

200.11140  
100MM CEILING PLATE  
100 / BOX



200.11160  
3MM BRACKET SHIM  
200 / BOX



200.11170  
12MM BRACKET SHIM  
100 / BOX

**005.11150 - STARTING KIT (TOOL AND SHIM)**  
(1 x 005.11100 + 1 x 005.11120 + 4 x 005.11110  
+ 100 x 200.11140 + 200 x 200.11160 + 100 x 200.11170)



000.00810  
SPRING PIN ø3 X 38MM LONG  
100 / BOX

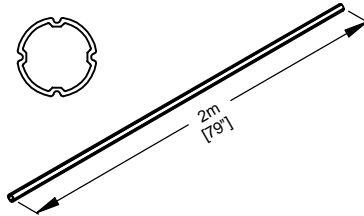

200.12970  
THREADED ROD COVER

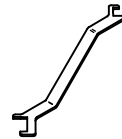

005.11100  
LOCK-UNLOCK TOOL

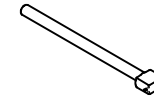

005.11120  
SPRING PIN TOOL



005.11110  
BRACKET REMOVING TOOL

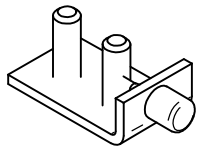

700.11000  
RAIL STOPPER

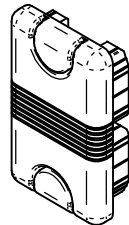

200.11060  
FLAT WHITE CAP FOR H RAIL

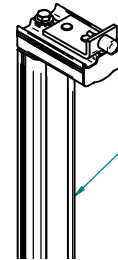

700.12900  
END OF TRACK WALL POST (1)

POST 2.5m  
LONG

---

KWIKTRAK

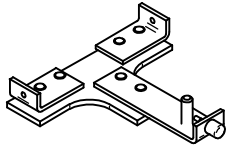

700.11220  
TRACK JUNCTION

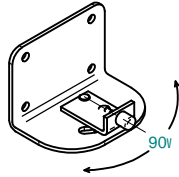

700.11020  
WALL BRACKET

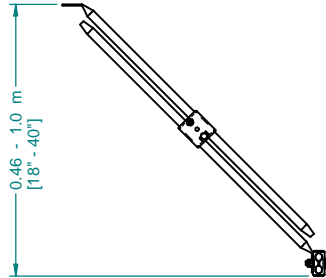

700.11350  
ADJUSTABLE LATERAL BRACE

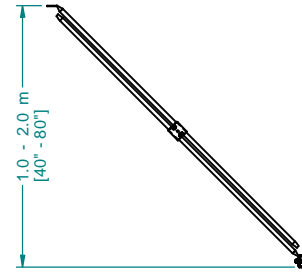

700.11360  
ADJUSTABLE LATERAL BRACE (LONG)

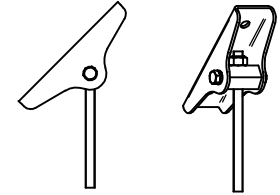

700.11370  
CATHEDRAL CEILING BRACKET

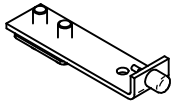

700.11010  
RAIL STOPPER  
(TECHNO, MIRTEK AND OLD BHM TRACK)

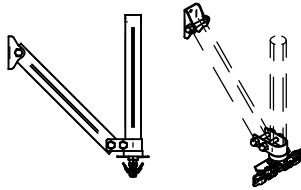

700.11380  
VISIBLE LATERAL BRACE

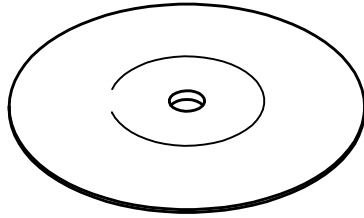

200.11140  
100MM CEILING PLATE  
QTY = 100



200.11160  
3MM BRACKET SHIM  
QTY = 200

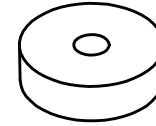

200.11170  
12MM BRACKET SHIM  
QTY = 100

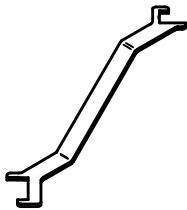

005.11100  
LOCK-UNLOCK TOOL  
QTY = 1

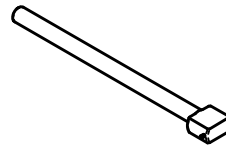

005.11120  
SPRING PIN TOOL  
QTY = 1



005.11110  
BRACKET REMOVING TOOL  
QTY = 4

**005.11150 - STARTING KIT (TOOLS AND SHIMS)**

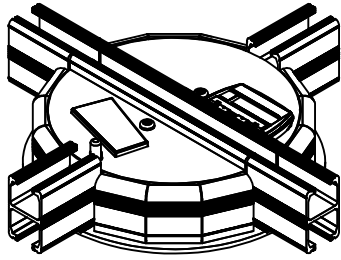

700.11600  
TURNTABLE

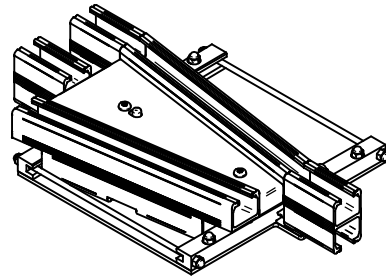

700.11700  
EXCHANGER

700.11500  
GATE

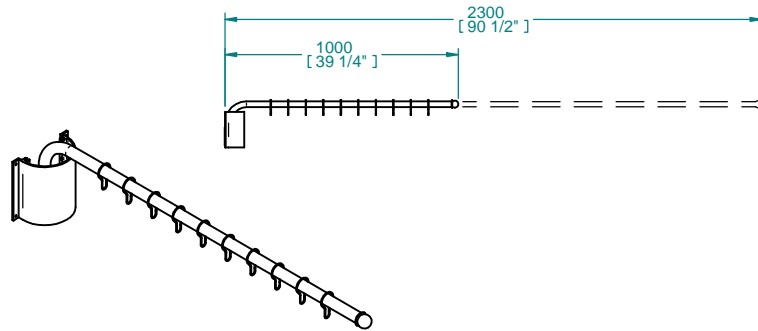

A9800  
TELESCOPIC SWIVEL POLE  
FOR SHOWER CURTAIN

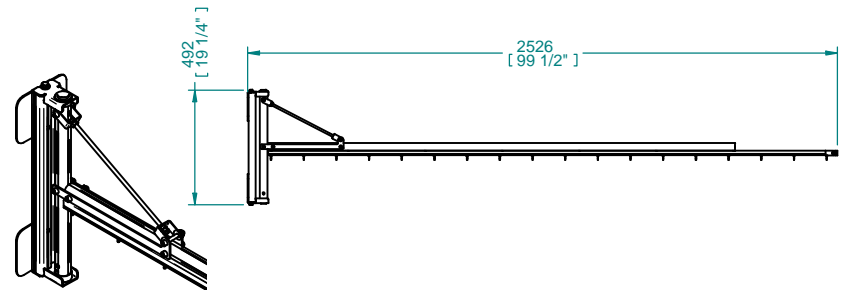

700.12000  
SWIVEL POLE FOR CURTAIN

**KWIKTRAK**

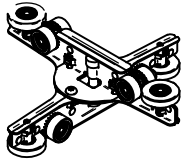

700.11290  
X-Y TROLLEY KIT

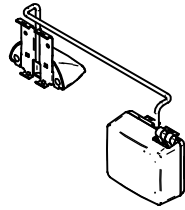
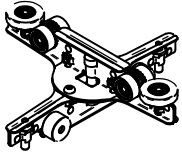

700.15510  
X-Y CHARGER INTERFACE  
(TO USE WITH 700.11290)

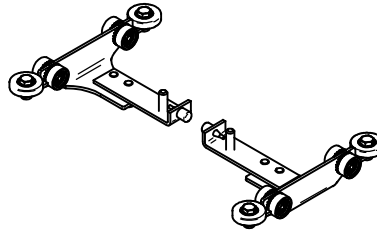

700.11295  
X-Y TROLLEY KIT FLUSH MOUNT  
(FOR PORTABLE TRACK LIFT ONLY)

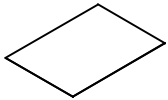

001.14045  
WHITE STICKER SHEET  
(COLOR OF RAIL)

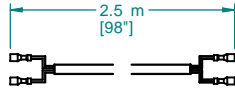

402.15505  
CHARGER CABLE EXTENSION

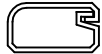

E0265  
SURFACE RACEWAY 1.8M [6']  
(SELF ADHESIVE)

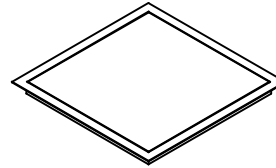

000.01260  
ACCESS DOOR 18" X 18"

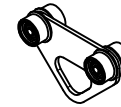

700.10650  
TROLLEY PORTABLE  
TRACK LIFT

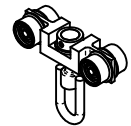

700.10620  
SWIVEL TROLLEY FOR VOYAGER  
PORTABLE TRACK LIFT



700.09010  
DEMO RACK FOR KWIKTRAK  
(TRACK NOT INCLUDED)



000.00423  
DROP-IN HILTI ANCHOR 3/8-16  
(HDI 3/8-16)



000.00427  
FLUSH MOUNT DROP-IN HILTI ANCHOR 3/8-16  
(HDI-L 3/8-16)



000.00428  
DROP-IN HILTI ANCHOR 3/8-16  
FOR HOLLOW CORE PRECAST CONCRETE SLAB  
(HDI-P 3/8-16)



000.00393  
3/8-16 X 36" THREADED ROD

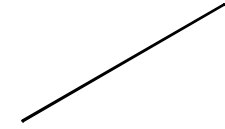

000.00394  
3/8-16 X 10" THREADED ROD



000.00405  
NUT 3/8-16



000.00402  
STOVER LOCKNUT 3/8-16



000.00410  
COUPLING NUT 3/8-16



000.04400  
NUT M10



000.04416  
STOVER LOCKNUT M10



000.04430  
FLAT WASHER 10mm ID

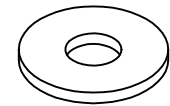

000.04875  
FLAT WASHER 12mm ID



000.00357  
3/8-16 X 1

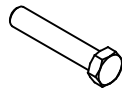

000.00381  
3/8-16 X 2

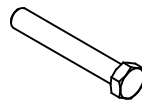

000.00385  
3/8-16 X 2 1/2

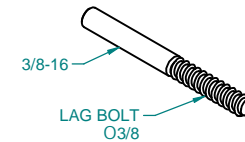

000.00745  
LAG SCREW 4"

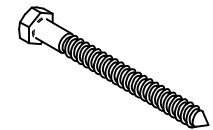

000.00740  
LAG BOLT 3/8 X 4" ZINC PLATED

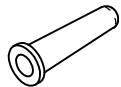

000.00655  
PLASTIC ANCHOR #10-12



000.00645  
TAP SCREW ST4.8 X 19 PHILLIPS

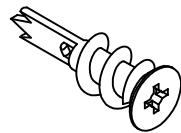

000.00650  
E-Z-ANCHOR  
(FOR SCREW #8 AND #10  
OR ST4.2 AND ST4.8)

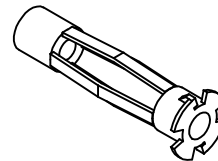

000.00660  
EXPANDABLE ANCHOR FOR GYPSUM  
(USE WITH M6 SCREW)

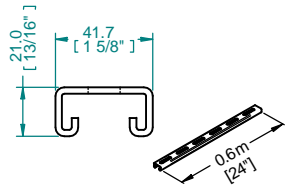

000.01210  
HILTI STRUT 13/16, WHITE, 24"

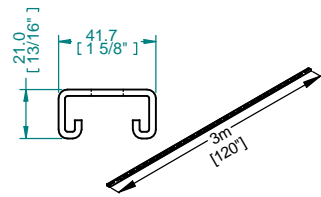

000.01205  
HILTI STRUT 13/16, WHITE, 10'

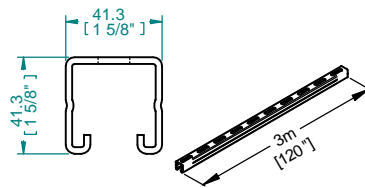

000.01230  
HILTI STRUT 10'

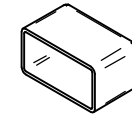

000.01215  
WHITE CAP FOR 13/16 HILTI STRUT

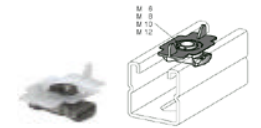

000.00426  
STRUT NUT  
(MKN-FM 3/8-16)



000.00424  
SADDLE NUT  
(MSA-F 3/8-16)

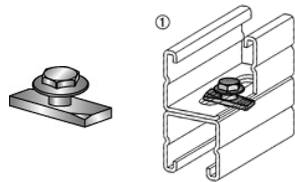

000.00490  
STRUT TIES  
(MKN-SV)



005.00495  
WRENCH FOR STRUT TIES  
(MKN-SVS WRENCH)

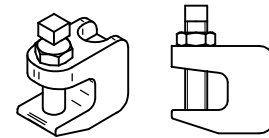

000.00412  
BEAM C-CLAMP 3/8"

---

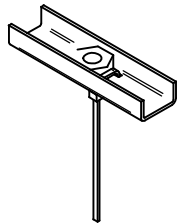

700.11090  
PRESSURE NUT 3/8-16

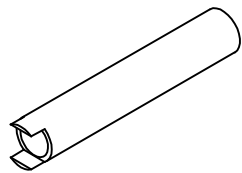

005.11090  
TOOL FOR PRESSURE NUT



PM 22  
SELF-LEVELING PLUMB LASER  
(00333649)



PR 16  
ROTATING LASER  
(00371897)



TE-6 DRILL  
CONTRACTOR CORDLESS ROTARY HAMMER DRILL  
(00334952)



SF 121-A 3.0 AH DRILL  
BATTERY POWERED  
(00340446)



TE-CX 0 1/2" X 6"  
CARBIDE TIPPED BIT FOR CONCRETE  
(00205352)



TE-CX 0 1/2" X 18"  
CARBIDE TIPPED BIT FOR CONCRETE  
(00205355)



HST 3/8 HAND SETTING TOOL  
(00032979)

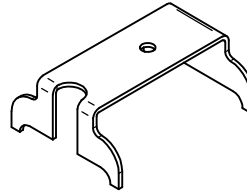

005.00010  
BRACKET ADAPTOR FOR PM-22 LASER

---

---



000.02690  
ALLEN KEY 5MM LONG

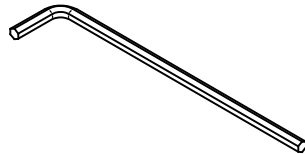

000.03280  
ALLEN KEY 6MM LONG

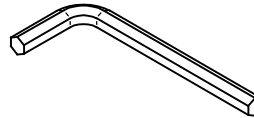

000.03975  
ALLEN KEY 8MM SHORT

---

---